



Flex Shaft Concrete Vibrators

Sure Speed 2.0 and 995



CONTENTS

General Power Tool Safety Warnings	5
Work Area Safety	5
Electrical Safety	5
Personal Safety	5
Power Tool Use and Care	5
Service	6
Emissions	6
Safety Symbol Explanations	6
Additional Safety Note	6
Introduction	7
Operation	7
Before Starting the Motor	7
Operating the Motor	7
Setup	8
Connecting the Vibrating Casing (Quick-Disconnect Connections)	8
Disconnecting the Vibrator Casing (Quick-Disconnect)	9
Connecting the Vibrating Casing (Threaded Connections)	9
Disconnecting the Vibrator Casing (Threaded Connector)	10
Parts	11
Preventive Maintenance	14
Brush Removal	14
Brush Replacement	14
Filter Replacement	14
Electric Vibrator Head Service and Maintenance	14
Flexible Shaft Lubrication and Break-in	15
Extension Cords	16
Electric Vibrator Head Assembly Drawings and Parts Lists	16
Vibrator Head Model 750-D	17
Vibrator Head Model 750-EH	17
Vibrator Head Models 750-FI, 750-GI, 750-LI and 750-MI	18
Vibrator Head Model 750-SBI	18

Restrictions of Hazardous Substances (Rohs) Directive 19
Waste Electrical and Electronic Equipment (WEEE) Directive 19

Model Number	_____
Serial Number	_____
Date Purchased	_____



WARNING: This product can expose you to chemicals including lead, which are known to the State of California to cause cancer, and Chromium, which are known to the State of California to cause birth defects and/or other reproductive harm. For more information go to www.P65Warnings.ca.gov

⚠️ WARNING

READ ALL SAFETY WARNINGS AND ALL INSTRUCTIONS. FAILURE TO FOLLOW THE WARNINGS AND INSTRUCTIONS MAY RESULT IN ELECTRIC SHOCK, FIRE AND/OR SERIOUS INJURY.

GENERAL POWER TOOL SAFETY WARNINGS

NOTE: Save all warnings and instructions for future reference.

NOTE: The term power tool in the warnings refers to your mains-operated (corded) power tool or battery-operated (cordless) power tool.

Work Area Safety

1. Keep work area clean and well lit.
2. Do not operate power tools in explosive atmospheres, such as in the presence of flammable liquids, gases or dust. Power tools create sparks which may ignite the dust or fumes.
3. Keep children and bystanders away while operating a power tool.

Electrical Safety

1. Power tool plugs must match the outlet. Never modify the plug in any way. Do not use any adapter plugs with earthed or grounded power tools. Unmodified plugs and matching outlets will reduce risk of electric shock.
2. Avoid body contact with earthed or grounded surfaces such as pipes, radiators, ranges, and refrigerators. There is an increased risk of electric shock if your body is earthed or grounded.
3. Do not expose power tools to rain or wet conditions. Water entering a power tool will increase the risk of electric shock.
4. Do not abuse the cord. Never use the cord for carrying, pulling or unplugging the power tool. Keep cord away from heat, oil, sharp edges or moving parts. Damaged or entangled cords increase the risk of electric shock.
5. When operating a power tool outdoors, use an extension cord suitable for outdoor use to reduce the risk of electric shock.

6. If operating a power tool in a damp location is unavoidable, use a residual current device (RCD) protected supply to reduce the risk of electric shock.

NOTE: The term residual current device (RCD) may be replaced by the term ground fault circuit interrupter (GFCI) or earth leakage circuit breaker (ELCB).

Personal Safety

1. Do not use a power tool while you are tired or under the influence of drugs, alcohol or medication to avoid risk of serious personal injury.
2. Always wear eye protection. Other protective equipment such as dust mask, non-skid safety shoes, hard hat, or hearing protection should be used in appropriate conditions to reduce personal injuries.
3. Make sure the switch is in the OFF position before connecting to power source and/or battery pack, picking up or carrying the tool.
4. Remove any adjusting key or wrench before turning the power tool on. A wrench or a key left attached to a rotating part of the power tool may result in personal injury.
5. Do not overreach. Keep proper footing and balance at all times.
6. Do not wear loose clothing or jewelry. Keep your hair, clothing and gloves away from moving parts. Loose clothes, jewelry or long hair can be caught in moving parts.
7. If devices are provided for the connection of dust extraction and collection facilities, make sure these are connected and properly used. Use of dust collection can reduce dust-related hazards.

Power Tool Use and Care

1. Do not force the power tool. Use the correct power tool for your application.
2. Do not use the power tool if the switch does not turn it on and off. Any power tool that cannot be controlled with the switch is dangerous and must be repaired.
3. Disconnect the plug from the power source and/or the battery pack from the power tool before making any adjustments, changing accessories, or storing power tools to reduce the risk of starting the power tool accidentally.
4. Store idle power tools out of the reach of children and do not allow persons unfamiliar with the power tool or these instructions to operate the power tool.
5. Maintain power tools. Check for misalignment or binding of moving parts, breakage of parts and any other condition that may affect operation. If damaged, have the power tool repaired before use.

6. Keep cutting tools sharp and clean.
7. Use the power tool, accessories, tool bits, and like equipment in accordance with these instructions, taking into account the working conditions and the work to be performed.

Service

Have your power tool serviced by a qualified repair person using only identical replacement parts to make sure the tool is safe to use.

Emissions

1. Declared noise emission values:

$$K = 0.69 \text{ dB}$$

$$L_{pA} = 83.1 \text{ dB}$$

$$L_{WA} = 94.1 \text{ dB}$$

NOTE: Wear hearing protection.

2. Declared vibrator emissions:

$$\text{Front Handle} = 4.28 \text{ m/s}^2$$

$$K = 1.50 \text{ m/s}^2$$

$$\text{Rear Handle} = 2.41 \text{ m/s}^2$$

$$K = 1.50 \text{ m/s}^2$$

NOTE: The declared vibration total value has been measured in accordance with a standard test method and may be used for comparing one tool with another. The declared vibration total value may also be used in a primary assessment of exposure.

WARNING

THE VIBRATION EMISSION DURING ACTUAL USE OF THE POWER TOOL CAN DIFFER FROM THE DECLARED TOTAL VALUE DEPENDING ON THE WAYS IN WHICH THE TOOL IS USED.

SAFETY SYMBOL EXPLANATIONS







V	Volts
A	Amperes
Hz	Hertz
	Alternating Current
	Class II Tool
IPX4	IP Symbol
	Ground Terminal (Protective Earthing)
I	ON
	OFF
	Refer to Instruction Manual
	Variability in Steps

Figure 1: Safety symbols

Additional Safety Note

Double insulated tools are equipped with a polarized plug (one blade is wider than the other). This plug will fit in a polarized outlet only one way. If the plug does not fit fully in the outlet, reverse the plug. If it still does not fit, contact a qualified electrician to install a polarized outlet. Do not change the plug in any way. Double insulation eliminates the need for the three-wire grounded power cord and grounded power supply system.

INTRODUCTION

This concrete vibrator motor is used to power concrete flex shaft vibrators which provide vibration to consolidate freshly poured concrete. The vibration is created by an eccentric (off center) weight within the vibrator head. As the weight spins it forces the head housing to move within the fresh concrete. The continuous head movement agitates the concrete mixture resulting in significantly reduced voids.

This motor can be used with any valid Wyco vibrator head and shaft combination. See [Table 1](#) for recommended combinations. Shafts are available in lengths of 2, 5, 7, 10, 14, 20 and 30 feet (0.61, 1.52, 2.13, 3.05, 4.27, 6.1 and 9.14 m).

⚠ WARNING

DO NOT USE NON-APPROVED PARTS. THE USE OF NON-APPROVED PARTS MAY CAUSE A HAZARDOUS CONDITION FOR THE OPERATOR.

Vibrator Head		Vibrator Shaft	
Size in. (mm)	Model No	Length ft (m)	CK Series
13/16 (4.76)	750-D	2...20 (0.61...6.1)	8900
1 (25.4)	750-EH		
1-3/8 (34.92)	750-FI	2...20 (0.61...6.1)	9500
1-3/4 (44.45)	750-GI		
2 (50.8)	750-LI		
2-1/4 (57.15)	750-MI		
2-1/2 (63.5)	750-SBI		
1-3/8 (34.92)	750-FI	30 (9.14)	

Table 1: Recommended Wyco head and shaft combinations

IMPORTANT

Third party approvals/certifications only apply when Product is used solely with head and shaft models listed in Product's user manual.

OPERATION

Before Starting the Motor

⚠ DANGER

DO NOT USE DAMAGED EQUIPMENT. INSPECT THE VIBRATOR FOR DAMAGE BEFORE USING THIS EQUIPMENT. READ, UNDERSTAND AND FOLLOW ALL SAFETY AND MAINTENANCE INSTRUCTIONS IN THIS MANUAL. CAREFULLY CHECK THAT THE POWER CORD HAS NO CUTS OR EXPOSED WIRES. VERIFY MOTOR HOUSING IS INTACT. CHECK ALL ACORN NUTS TO VERIFY THEY ARE TIGHTENED.

⚠ DANGER

DO NOT START THE MOTOR WITHOUT A SHAFT CONNECTED. THE EXPOSED SHAFT CONNECTION PRESENTS A SAFETY HAZARD AS IT ROTATES AT HIGH SPEED. CLOTHING OR SKIN MAY BECOME ENTANGLED IN THE SHAFT CONNECTION CAUSING INJURY.

Make sure that the motor, shaft and head are connected securely. See "[Setup](#)" on [page 8](#).

Make sure that the power plug is connected to the appropriate power source.

Make sure that the motor is not immersed in concrete and that any cord connections are not in water or fresh concrete.

Operating the Motor

1. Turn vibrator on by moving the rocker switch to **I**.

NOTE: The SureSpeed has been designed with a soft start and will ramp up to speed over a 1 second period.

2. Insert the vibrator head into the concrete to be consolidated.
Do not run the vibrator head outside of fresh concrete for an extended period of time. The vibrator depends on moving concrete to cool the bearings.
Avoid sharp bends in the flex shaft during operation. Sharp bends reduce shaft life.
3. Remove the vibrator head from concrete and turn the rocker switch to **O**.

SETUP

The motor has several options for connecting the core and casing assembly to the motor housing. For all available connections, see *"Parts"* on page 11.

Connecting the Vibrating Casing (Quick-Disconnect Connections)

NOTE: The casing must be fitted with a quick-disconnect end.

1. Make sure the locking lever on the quick-disconnect connector on the motor is in the up position. See [Figure 2](#).

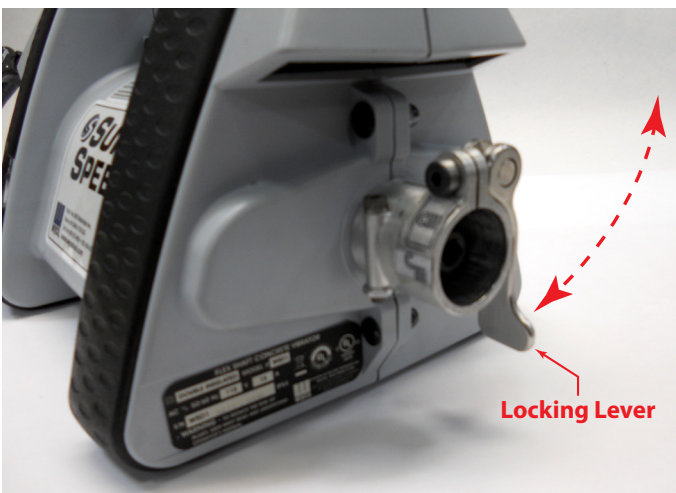

Figure 2: Quick-disconnect fitting

2. Locate the core and casing.
3. Identify the side of the casing that has the connection arrow.
4. Position the casing with the arrow face to the left as viewed from the vibrator head end. This side should face to the left when the casing is held directly behind the quick-disconnect. See [Figure 3](#).



Figure 3: Casing arrow location

5. Align the end of the core with the driver inside the quick-disconnect fitting on the motor.

6. Align the arrows on the casing end with the unlock icon on the quick-disconnect connector. The unlock and lock positions are shown by the unlock and lock icons (see [Figure 4](#)) on the side of the quick-disconnect fitting. See [Figure 5](#).

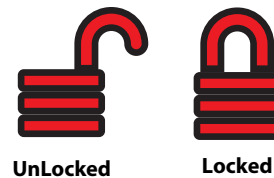

Figure 4: Unlock/Lock icons

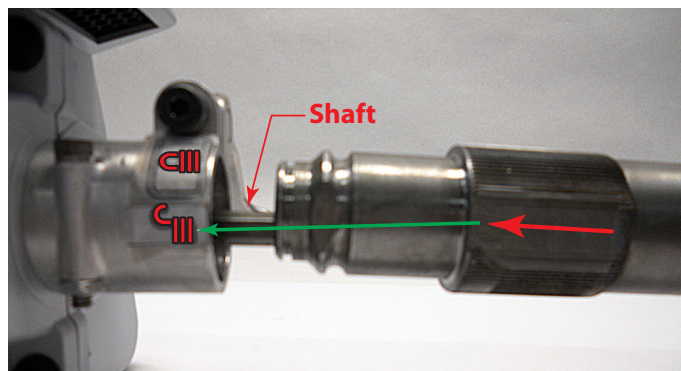

Figure 5: Core/Casing alignment

7. Insert the casing into the core.
8. Line up the shaft and driver so the shaft slides into the driver.
9. Rotate the casing until the arrow lines up with the lock icon on the quick-disconnect connector.
10. Push down on the locking lever to clamp the casing into the quick-disconnect connector. The locking lever bottoms out on the side of the quick-disconnect connector.

NOTE: If the casing feels loose or too tight after pushing down on the locking lever, raise the lever until the lever is horizontal then rotate the hex head screw with a #4 Allen wrench in either direction to tighten or loosen. Be careful to not loosen the lever too far or the lever bushing and screw will unthread and could fall apart. After the adjustments are completed, push lever back down to bottom out to connector. This procedure may need to be repeated to get desired tight or lose condition. See [Figure 6](#).

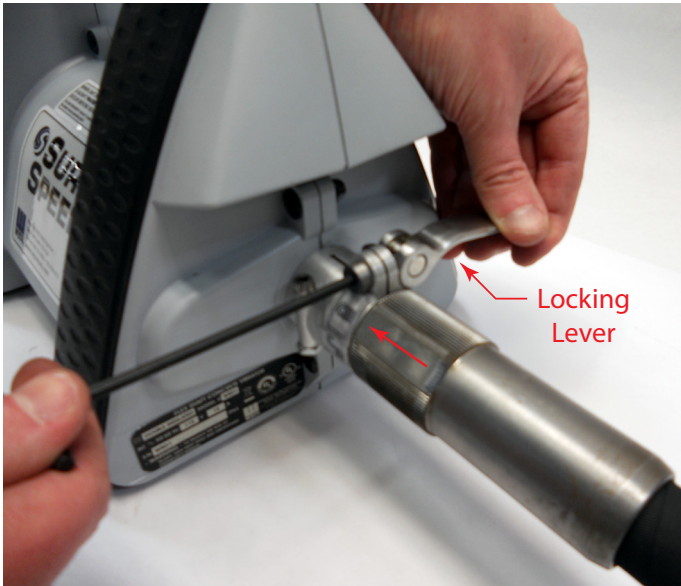

Figure 6: Locking lever adjustment

Disconnecting the Vibrator Casing (Quick-Disconnect)

1. Make sure the quick-disconnect locking lever on the motor is in the up position.
2. Rotate the core and casing counterclockwise from the lock position to the unlock position.
3. Pull the casing end straight out of the quick-disconnect connector on the motor.
4. Make sure that the locking lever is in the down position when storing the motor to avoid damage to the lever.

Connecting the Vibrating Casing (Threaded Connections)

NOTE: The casing must be fitted with a thread connector end.

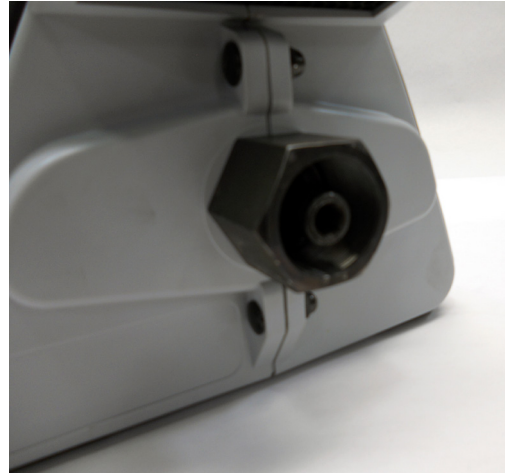

Figure 7: Threaded casing connector

1. Line up threads of the shaft with the threaded motor connector. Hold the casing end firmly and rotate the casing until it engages into the motor.

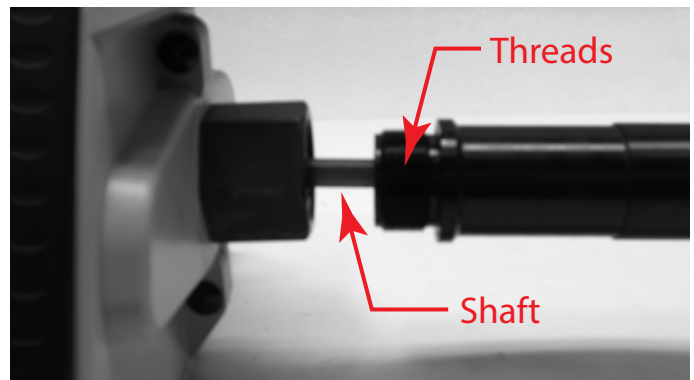

Figure 8: Shaft insertion

2. Hold the casing assembly in one hand while carefully rotating the motor counterclockwise until motor is snug to the shaft. See [Figure 9](#).

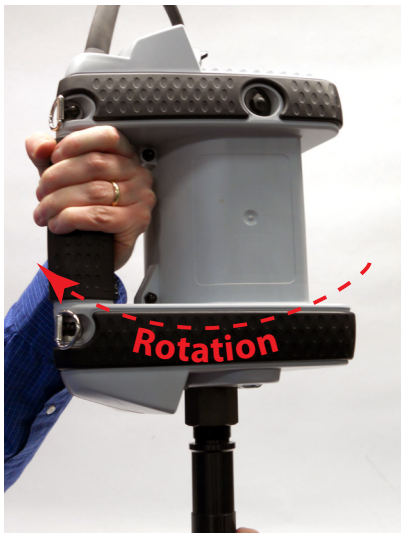

Figure 9: Motor rotation

NOTE: The motor may be taken off of the work surface, allowing the motor housing to spin in the air while holding onto the flex shaft with a hand or with vise. Do not over tighten or reef as this may damage the plastic motor housing.

3. Once threads are started, rotate motor assembly until the motor assembly stops turning. See [Figure 9](#).
4. Use a crescent wrench to hold the hex motor connector and a pipe wrench on the flex shaft to tighten. See [Figure 10](#).



Figure 10: Crescent wrench and pipe wrench placement

5. The vibrator assembly is now ready to use.

Disconnecting the Vibrator Casing (Threaded Connector)

1. Carefully loosen the hex motor connector, using a crescent wrench on the motor and a pipe wrench on the flex shaft assembly, until the motor assembly can be rotated by hand in a counterclockwise direction. See [Figure 10](#).



Figure 11: Hex motor connection

2. Carefully rotate the motor until it and the casing separate from one another. Do not pull the core end too far out of the casing end or the head will have to be removed to realign the core with the head driver.

⚠ WARNING

TIGHTENING OR TORQUING USING THE MOTOR HANDLE CAN CAUSE DAMAGE TO MOTOR CASING.

The motor can accommodate any of the 750 series cores and casings.

The motor is ordered as either a quick-disconnect connection or a threaded connection version.

If the threaded version was ordered it cannot be used with the quick-disconnect core and casing. If the quick-disconnect version was ordered threaded core and casings can be used with the addition of a thread to quick-disconnect adapter. The configuration options are shown in ["Parts" on page 11](#).

PARTS

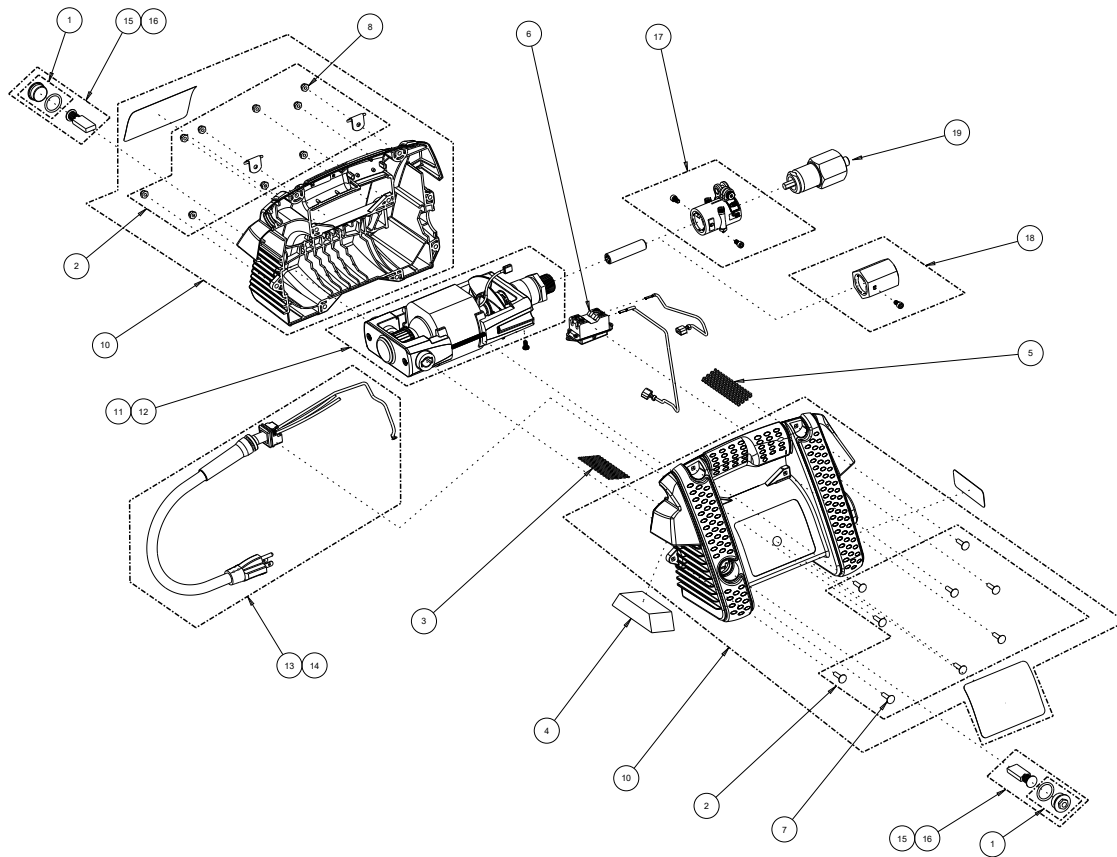

Item	Kit Number	Description	Parts Included (Parts Quantity)
1	W423114	Brush cap with O-ring, 115V	Brush cap (2); O-ring, brush cap (2)
2	W423144	Bolt and nut with D-ring kit (housing)	Acorn nut, 10-32 unf, self locking (9); Carriage screw, 10-32 unf x 3/4 in. (9); D-ring (2)
3	W423130	Intake screen	(1)
4	W423132	Intake filter	(1)
5	W423131	Exhaust screen	(1)
6	W423110	Rocker switch; 20 A 125-250V AC	(1)
7	W423140	Carriage screw, 10-32 unf x 3/4 in.	(1)
8	W423141	Acorn nut, 10-32 unf, self locking	(1)
9	W819013	Carrying strap (not shown)	(1)
10	W423239	Housing replacement kit, gold	Acorn nut, 10-32 unf, self locking (9); Carriage screw, 10-32 unf x 3/4 in. (9); D-ring (2); label, 995 (1); Label, head chart (1); Left housing assembly, gold (1); Right housing assembly, gold (1)
11	W423600	Motor assembly, 115 Volt ¹	(1)
12	W423601	Motor assembly, 230 Volt ²	(1)
13	W423155	115 Volt 3-wire cord set kit ¹	115V cord set, 3-wires with plug (1); Cord bend relief (1); Cord strain relief bushing (1)
14	W423157	230 Volt 3-wire cord set kit ²	230V cord set, 3-wires with plug (1); Cord bend relief (1); Cord strain relief bushing (1)
15	W423235	115 Volt brush, cap and O-ring kit ¹	Brush cap (2); O-ring, brush cap (2); Brush and spring assembly, 115V (2)
16	W423236	230 Volt brush, cap and O-ring kit ²	Brush cap (2); O-ring, brush cap (2); Brush and spring assembly, 230V (2)
17	W423240	Q.D. Connector kit ³	Complete Q.D. Motor connector assembled with set screws
18	W423241	Threaded connector kit ⁴	Threaded hex motor connector with set screw
19	W423-500	Threaded to Quick-Disconnect Adapter	(1)

¹Available for Model Numbers W995G1Q and W995G1T

²Available for Model Numbers W995G2Q and W995G2T

³Available for Model Numbers W995G1Q and W995G2Q

⁴Available for Model Numbers W995G1T and W995G2T

Figure 12: Repair parts for 995

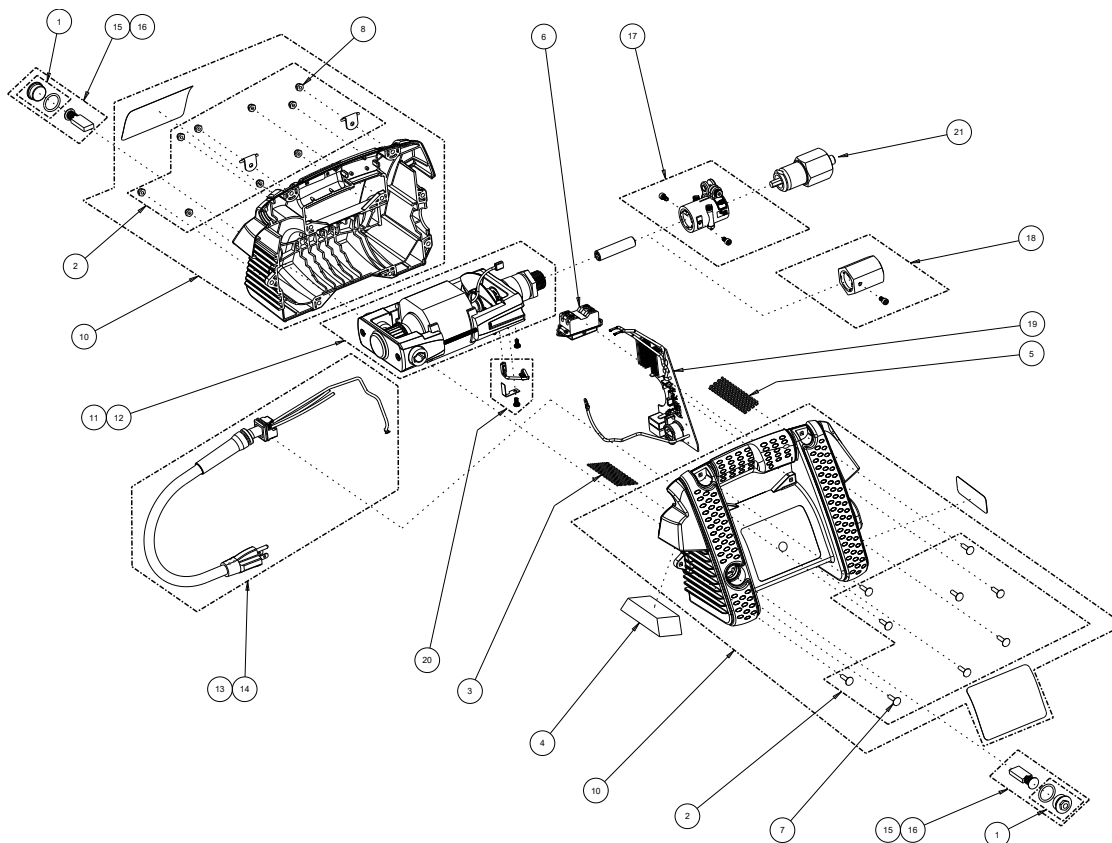

Item	Kit Number	Description	Parts Included (Parts Quantity)
1	W423114	Brush cap with O-ring, 115V	Brush cap (2); O-ring, brush cap (2)
2	W423144	Bolt and nut with D-ring kit (housing)	Acorn nut, 10-32 unf, self locking (9); Carriage screw, 10-32 unf x 3/4 in. (9); D-ring (2)
3	W423130	Intake screen	(1)
4	W423132	Intake filter	(1)
5	W423131	Exhaust screen	(1)
6	W423110	Rocker switch; 20 A 125-250V AC	(1)
7	W423140	Carriage screw, 10-32 unf x 3/4 in.	(1)
8	W423141	Acorn nut, 10-32 unf, self locking	(1)
9	W819013	Carrying strap (not shown)	(1)
10	W423239	Housing replacement kit, black	Acorn nut, 10-32 unf, self locking (9); Carriage screw, 10-32 unf x 3/4 in. (9); D-ring (2); label, Sure Speed 2.0 (1); Label, head chart (1); Left housing assembly, black (1); Right housing assembly, black (1); Sure Speed soft start label (1)
11	W423600	Motor assembly, 115 Volt ¹	(1)
12	W423601	Motor assembly, 230 Volt ²	(1)
13	W423155	115 Volt 3-wire cord set kit ¹	115V cord set, 3-wires with plug (1); Cord bend relief (1); Cord strain relief bushing (1)
14	W423157	230 Volt 3-wire cord set kit ²	230V cord set, 3-wires with plug (1); Cord bend relief (1); Cord strain relief bushing (1)
15	W423235	115 Volt brush, cap and O-ring kit ¹	Brush cap (2); O-ring, brush cap (2); Brush and spring assembly, 115V (2)
16	W423236	230 Volt brush, cap and O-ring kit ²	Brush cap (2); O-ring, brush cap (2); Brush and spring assembly, 230V (2)
17	W423240	Q.D. Connector kit ³	Complete Q.D. Motor connector assembled with set screws
18	W423241	Threaded connector kit ⁴	Threaded hex motor connector with set screw
19	W425500	Sure speed control board	(1)
20	W423170	Hall effect sensor kit	Hall effect sensor; Hall effect sensor guard; Screw, 8-32 w/tooth lock washer
21	W423-500	Threaded to Quick-Disconnect Adapter	(1)

¹Available for Model Numbers WSS2G1Q and WSS2G1T

²Available for Model Numbers WSS2G2Q and WSS2G2T

³Available for Model Numbers WSS2G1Q and WSS2G2Q

⁴Available for Model Numbers WSS2G1T and WSS2G2T

Figure 13: Repair parts for Sure Speed 2.0

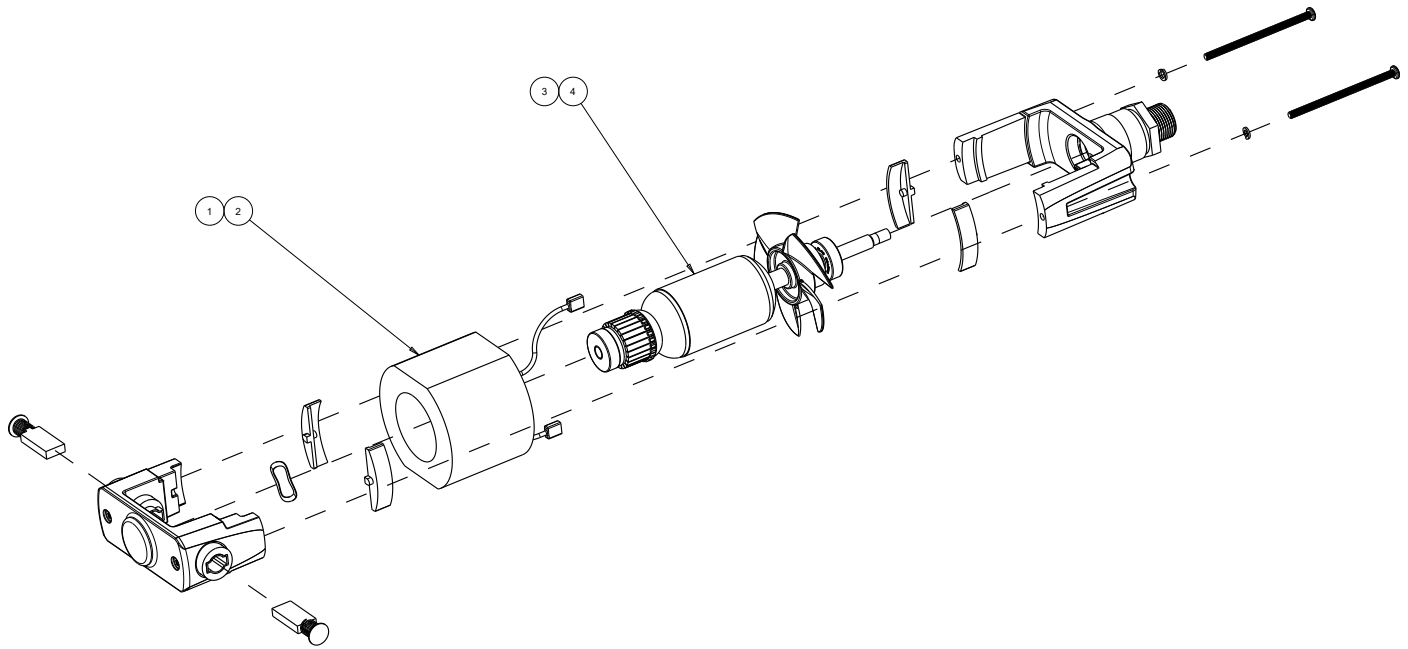

Item	Kit Number	Description	Parts Included (Parts Quantity)
1	W423603	Field; 15 Amp; 115 Volt ¹	(1)
2	W423605	Field; 7.5 Amp; 230 Volt ²	(1)
3	W423650	115 Volt armature kit ¹	Assembly, armature, 115 Volt, with bearings, fan and magnet; 115V brush, cap and o-ring kit (not shown)
4	W423651	230 Volt armature kit ²	Assembly, armature, 230 Volt, with bearings, fan and magnet; 230V brush, cap and o-ring kit (not shown)

¹Available for Model Numbers W995G1Q, W995G1T, WSS2G1Q and WSS2G1T

²Available for Model Numbers W995G2Q, W995G2T, WSS2G2Q and WSS2G2T

Figure 14: Motor kits

PREVENTIVE MAINTENANCE

Wyco vibrator motors are designed to operate 50...100 hours between normal preventive maintenance intervals. The service instructions below should be followed to perform the preventive maintenance.

⚠ WARNING

THERE ARE NO USER SERVICEABLE PARTS CONTAINED WITHIN THE MOTOR HOUSING. OPENING THE MOTOR HOUSING MAY BE DANGEROUS AND WILL VOID THE WARRANTY. ANY REPAIRS THAT REQUIRE OPENING THE MOTOR HOUSING SHOULD BE PERFORMED AT AN AUTHORIZED WYCO SERVICE CENTER OR AT THE WYCO FACTORY. USE ONLY FACTORY AUTHORIZED REPLACEMENTS PARTS.

Brush Removal

For the location of the parts used in the following procedures see ["Parts" on page 11](#).

1. Disconnect the line cord from the power source.
2. Lay the motor on its side with the brush cap (6) facing up.
3. Use a 1/2 in. 6-sided socket to unscrew the plastic brush cap (6) from the motor half.
4. The brush spring (5) will pop out. Carefully remove the brush spring by gently pulling on the spring.
5. Repeat these steps for the opposite side.

Brush Replacement

NOTE: Brushes should be replaced in pairs.

1. Inspect and replace damaged O-rings.
2. Lubricate the O-ring prior to cap installation
3. Align the new brush (5) with brush holder.
4. Insert the new brush.
5. Push the spring into the holder as you screw the brush cap back into the housing.

NOTE: The O-ring must be on the brush cap before you screw the cap into the housing.

6. Torque the brush cap (6) to 35 in. lb.
7. Repeat these steps for the opposite side.

Filter Replacement

1. Pull the old filter down from the housing with your fingers.
2. Place the new filter (2) in the housing, tapered side up. See ["Parts" on page 11](#).

ELECTRIC VIBRATOR HEAD SERVICE AND MAINTENANCE

IMPORTANT

Service the vibrator head after every 50 hours of operation for trouble-free running on the job.

When servicing, always replace the hex driver, seals and bearings, or bushing for 750-D & 750-EH heads.

See ["Electric Vibrator Head Assembly Drawings and Parts Lists" on page 16](#).

All heads are equipped with seals at the flexible shaft end and contain oil. The seals serve a double purpose; to keep the oil in the head and to keep the grease from the flexible shaft out of the head.

1. Hold the nose end in a vise and unscrew the end cap counterclockwise with a chain wrench or a good pipe wrench. See [Figure 15](#).



Figure 15: End cap removal

- Pull the eccentric rotor assembly out of the housing.

NOTE: If the bearings are stuck and you have difficulty removing them from the housing, screw the end cap partly back into the housing and bounce the head and cap down on a block of wood in order to loosen the bearings from their seat, then pull out the rotor assembly. See [Figure 16](#).

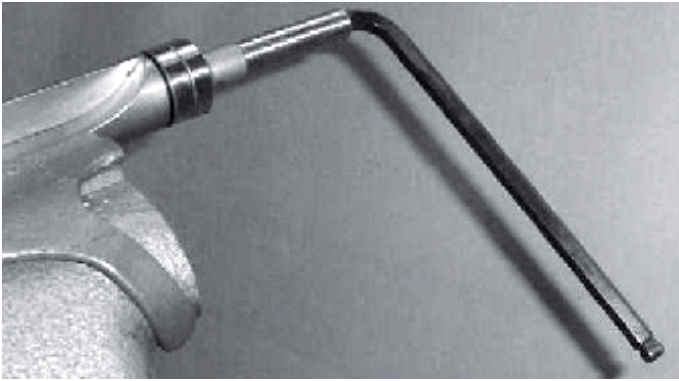

Figure 16: Bearing Removal

NOTE: The hexagon driver has left hand threads.

- Flush the rotor assembly and housing with solvent and wipe all parts clean.
- Replace bearings, seals and hex driver. Maintain concentric alignment of the hex driver with respect to the rotor shaft.
- Refill with proper amount of Wyco non-foaming vibrator oil. See [Table 2](#).
- Apply Loctite 545 adhesive/sealant or equivalent to threads on both ends of rotor.

Head Model	Head Size in. (mm)	Oil Required
750-D	13/16 (20.64) Square	1/2 oz (14 g)
750-EH	1 (25.4) Square	3/4 oz (21 g)
750-FI	1-3/8 (34.93) Square	1 oz (28 g)
750-GI	1-3/4 (44.45) Square	1-1/4 oz (35 g)
750-LI	2 (50.8) Square	2 oz (57 g)
750-MI	2-1/4 (57.15) Square	3-1/2 oz (99 g)
750-SBI	2-1/2 (63.5) Round	1-1/4 oz (35 g)

Table 2: Head oil requirements

- Replace the rotor assembly into the head housing.
- Apply Loctite 545 adhesive/sealant or equivalent all around the threads of the end cap.
- Tighten and wipe off excess Loctite 545 adhesive/sealant.

Flexible Shaft Lubrication and Break-in

When vibrators are shipped completely assembled from the factory, the shafts are lubricated and broken-in. If separate cores and casings are shipped, they require the following lubrication and break-in procedure. Core and casing combinations should be checked for lubricant levels at least every 50 hours.

Lubrication Procedure

To lubricate, lightly coat the core with grease (Wyco shaft lubricant) while inserting it into the casing.

IMPORTANT

Do not over lubricate. Surplus lubricant may get past the seal in the vibrator head. Over lubrication will also increase the amount of torque required to operate the vibrator, resulting in additional stress on the motor and possibly early core and casing failure.

When adding lubricant on the job, after each 50 hours of operation:

- Loosen the casing from the motor.
- Pull out the core about 15...18 in. (318... 457.2 mm).
- Apply lubricant as above to the exposed section of core.
- Reinstall the core, making sure that it engages with the vibrator head. During operation, the grease will travel the full length of the casing.

Break-in Procedure

A break-in procedure is required after the assembly of separately shipped core and casing. To break it in, repeatedly coil the flex shaft from the head to the motor while the motor is running. The coiling and uncoiling should be repeated at least three times for proper break-in.

NOTE: For shorter core and casing combinations, coiling is not possible. Break-in for short core and casings requires bending into a U-shape instead of a coil.

Water is one of the greatest enemies of satisfactory performance of vibrator heads. As the head is submerged in the mix, water and cement can infiltrate into the head unless precautions are taken. In addition to securely tightening the head onto the flexible shaft, the threads on the head and shaft must be coated with Permatex Form-A-Gasket No. 2. This must be done each and every time that the head is removed and reinstalled.

Extension Cords

When selecting an extension cord for use with Wyco electric motor cord sets using a three-prong polarized plug, an equivalent plug set must be used for the grounded or earthed version.

IMPORTANT

A grounded or earthed motor requires a grounded or earthed extension cord.

A two-prong extension cord may be used for the double insulated motor. Extension cords must be approved for outdoor use and the wire gauge of the cord must be appropriate for the expected load. See [Table 3](#).

Motor Type	Voltage	Rated Amps	Minimum Wire Size	Maximum Cord Length
WSS2G1Q	115V AC(±15V AC)	15	14 AWG	100 ft (30.48 m)
WSS2G1T				
W995G1Q			12 AWG	
W995G1T				
WSS2G2Q	230V AC (±30V AC)	7.5	16 AWG	100 ft (30.48 m)
WSS2G2T				
W995G2Q			16 AWG	
W995G2T				

Table 3: Extension cord wire minimum size requirements

ELECTRIC VIBRATOR HEAD ASSEMBLY DRAWINGS AND PARTS LISTS

Vibrator Head Model	Marking on End Cap	Square Size in. (mm)	Assembly Part No
750-D	D	3/16 (4.76)	W877-520
750-EH	EH	1 (25.4)	W877-526
750-FI	1.38B	1-3/8 (34.92)	W878-533
750-GI	1.75B	1-3/4 (44.45)	W878-540
750-LI	2.00B	2 (50.8)	W878-563
750-MI	2.25B	2-1/4 (57.15)	W878-568

Table 4: Electric vibrator head models

NOTE: Vibrator head model 750-SBI is a 2-1/2 in. (63.5 mm) round head with no end cap marking. Assembly PN is # W877-512.

Vibrator Head Model 750-D

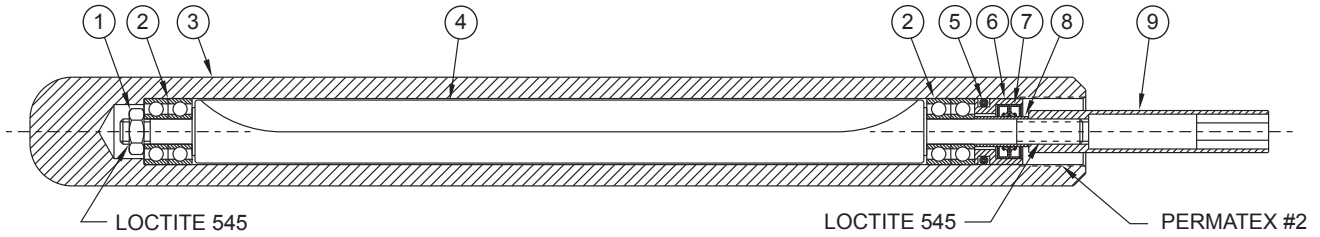

Item	Description	Quantity	Part No.	Item	Description	Quantity	Part No.
1	Nut, Hex Jam	1	W435638	6	Holder, Seal	1	*
2	Bearing, Ball	4	W097011	7	Seal, Oil	2	*
3	Housing, Square	1	W587320	8	Bushing	1	*
4	Rotor	1	W717340	9	Driver, Hex	1	W382428
5	O-Ring, Buna	1	*	* All of these items available assembled in a kit, PN W747-540.			

Figure 17: Model 750-D parts

Vibrator Head Model 750-EH

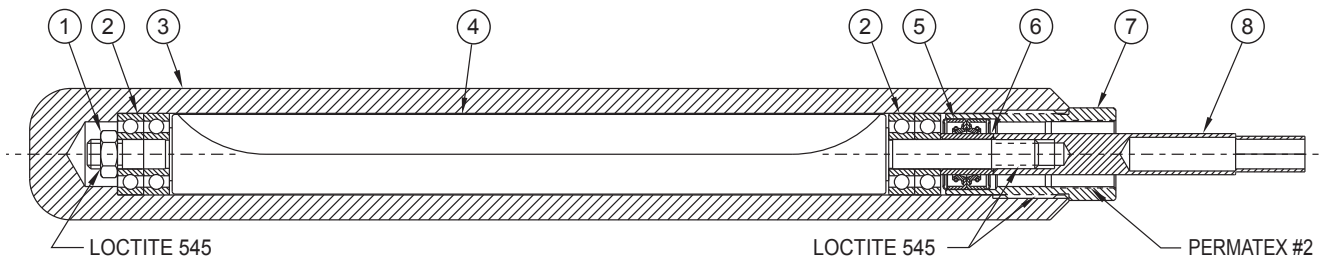

Item	Description	Quantity	Part No.	Item	Description	Quantity	Part No.
1	Nut, Hex Jam	1	W432710	6	Bushing	1	W177325
2	Bearing, Ball	4	W097012	7	End Cap	1	**
3	Housing, Square	1	W587325	8	Driver, Hex	1	W384447
4	Rotor	1	W717345	** End cap assembly with seals is PN W207-248.			
5	Seal, Oil	2	**	(Order bushing separately.)			

Figure 18: Model 750-EH parts

Vibrator Head Models 750-FI, 750-GI, 750-LI and 750-MI

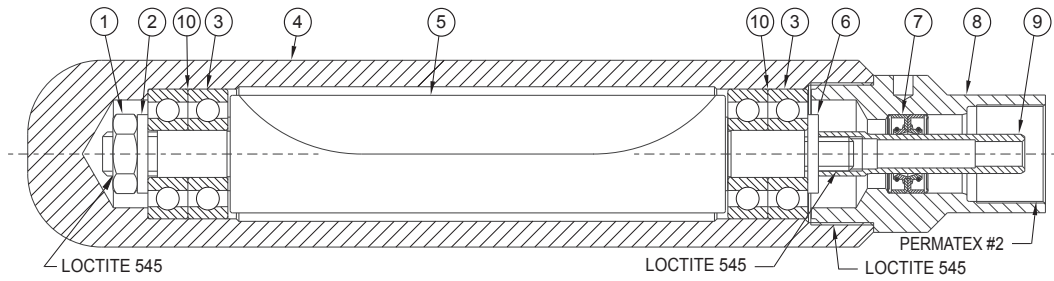

Item	Description	Quantity	Part No. for 750-FI (1.38B)	Part No. for 750-GI (1.75B)	Part No. for 750-LI (2.00B)	Part No. for 750-MI (2.25B)
1	Nut, Hex Jam	1	W432708		W432707	
2	Washer, Flat	1	W887015		W887011	
3	Bearing, Ball	4	W096013	W096010	W096011	W096020
4	Housing, Square	1	W588331	W588339	W588354	W588368
5	Rotor	1	W718357	W718335	W717360	W718365
6	Washer, Flat	1	W887015		W887016	
7	Seal, Oil	2	***			
8	End Cap	1	***			
9	Driver, Hex	1	W384446			
10	Shim	2	W419701		N/A	

*** Manufacturer suggests using end cap with pressed in seals: 1.38B - PN W208-231; 1.75B - PN W208-236; 2.00B - PN W208-261; 2.25B - PN W208-268. However, seal and end cap are available separately upon request.

Figure 19: Model 750-FI, GI, LI and MI parts

Vibrator Head Model 750-SBI

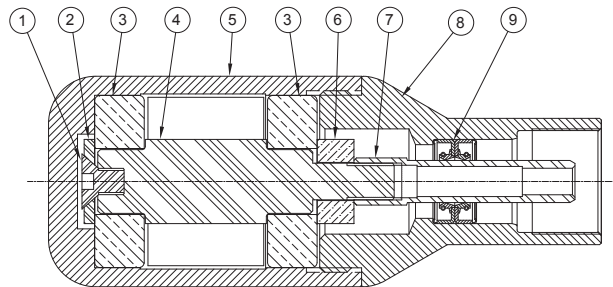

Item	Description	Quantity	Part No.	Item	Description	Quantity	Part No.
1	Screw, Hex Socket	1	W437510	6	Washer, Spacer	1	W887018
2	Washer, Flat	1	W887017	7	Driver, Hex	1	W384446
3	Bearing, Ball	2	W099910	8	End Cap	1	W207268
4	Rotor	1	W717310	9	Seal, Oil	2	W747504
5	Housing	1	W587310				

Figure 20: Model 750-SBI parts

RESTRICTIONS OF HAZARDOUS SUBSTANCES (ROHS) DIRECTIVE

This product is compliant with the RoHS Directive identified on the Declaration of Conformity associated with this product. This product does not contain lead, mercury, cadmium, hexavalent chromium, polybrominated biphenyls or polybrominated diphenyl ethers in quantities exceeding the following maximum concentration value levels:

Lead	0.1% by weight in homogenous materials
Mercury	0.1% by weight in homogenous materials
Hexavalent Chromium	0.1% by weight in homogenous materials
Polybrominated Biphenyls (PBB)	0.1% by weight in homogenous materials
Polybrominated Diphenyl Ethers (PBDE)	0.1% by weight in homogenous materials
Cadmium	0.01% by weight in homogenous materials

WASTE ELECTRICAL AND ELECTRONIC EQUIPMENT (WEEE) DIRECTIVE



In the European Union, this label indicates that this product should not be disposed of with household waste. It should be deposited at an appropriate facility to enable recovery and recycling.

For information on how to recycle this product responsibly in your country, please visit: www.badgermeter.com





Trademarks appearing in this document are the property of their respective entities.

Due to continuous research, product improvements and enhancements, Badger Meter reserves the right to change product or system specifications without notice, except to the extent an outstanding contractual obligation exists. © 2020 Badger Meter, Inc. All rights reserved.

wycosales@badgermeter.com | www.wycotool.com

Phone: 262-639-6770 | 800-233-9926 | Fax: 262-639-2023